

■ GEBERIT

150
YEARS
OF TOMORROW

FLOOR-EVEN SHOWERS SOLUTION
**CLEVER IDEAS
FOR BETTER
BATHROOMS**

**KNOW
HOW
INSTALLED**



Geberit shower channels in the CleanLine series combine an elegant appearance with the easy installation of a floor drain. In addition, the innovative system solves the hygiene problem many shower channels have.



No hidden gutters means no chance of any dirt or bacteria deposits. The removable comb insert makes the drain easy to keep clean



Floor-even access for completely tiled shower areas



Classic stainless steel, on-trend in coloured metallic tones, discreet as a tile-bearing profile



NARROW AND FUNCTIONAL: THE NEW GEBERIT CLEANLINE50 SHOWER CHANNEL

With a width of just three centimetres, the CleanLine50 complements the range of Geberit CleanLine shower channels with a new design variant. Technically, the new CleanLine50 shower channel scores points with proven features: easy cleaning, guaranteed tightness and integrated slope. It is available in two colours and finishes: brushed stainless steel and black chrome with anti-fingerprint coating.

GEBERIT SHOWER CHANNEL IN THE CLEANLINE SERIES

DESIGN SOLUTION IN THE FLOOR

- Extremely high customer satisfaction thanks to simple cleaning and modern linear appearance.
- Suitable for tiled and PUR flooring.
- Can be cut directly to the required length during installation.



DESIGN OPTIONS TO SUIT ANY BATHROOM STYLE

The shower channel is available in various design options with three different shapes of stainless-steel profile: the Geberit CleanLine20, CleanLine50 and CleanLine80 shower channel. The new Geberit shower channel CleanLine80 features a high-quality, self-contained channel profile with an integrated slope and can be ordered in the on-trend metallic tones of champagne, black chrome and classic stainless steel.



DESIGNED FOR CLEANLINESS

The collector profile drains all traces of water and dirt. It can be kept clean by simply wiping it down. The comb insert in the drain traps hair to keep it out. This can be removed in no time and washed out with ease.

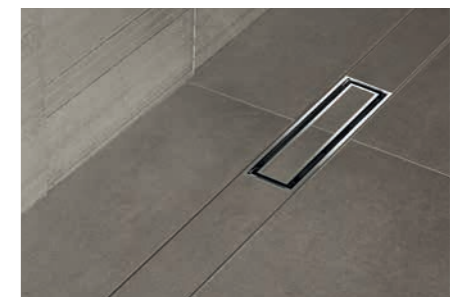

TILE-BEARING

The tile-bearing model of Geberit shower channels in the CleanLine series can be discreetly adapted to suit the floor tiles.

GEBERIT SHOWER CHANNEL IN THE CLEANLINE SERIES

- Easy access to the drain
- Suitable for installation centrally and close to the wall
- Classic and discreet linear design, suitable for virtually any floor—even shower area



- Unique design with cover profile, comb insert and drain
- Effortless installation thanks to complete installation kit
- Premounted sealing foil securely injected ex works for reliable sealing
- Length and positioning flexibly adjustable

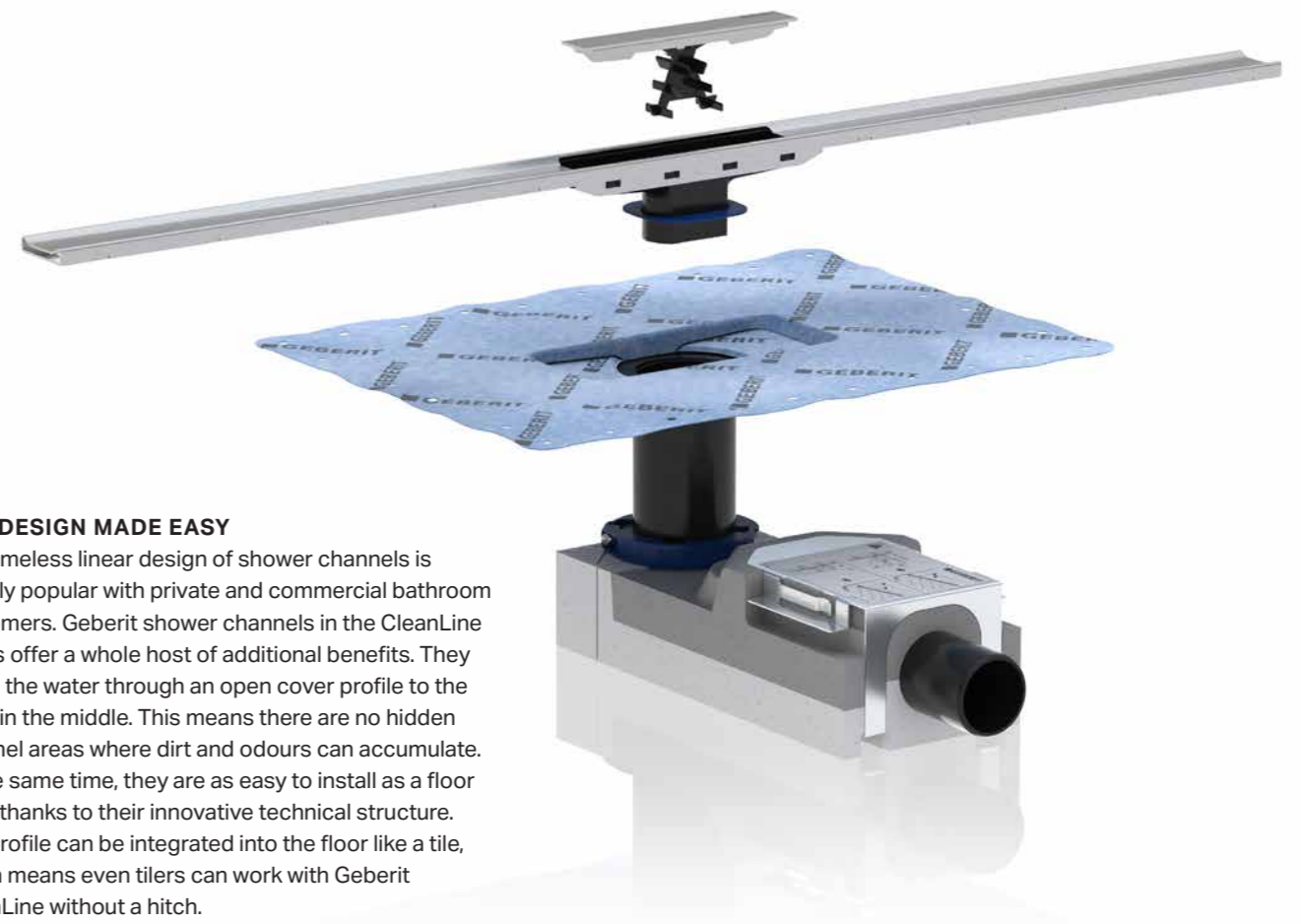

TOP DESIGN MADE EASY

The timeless linear design of shower channels is equally popular with private and commercial bathroom customers. Geberit shower channels in the CleanLine series offer a whole host of additional benefits. They guide the water through an open cover profile to the drain in the middle. This means there are no hidden channel areas where dirt and odours can accumulate. At the same time, they are as easy to install as a floor drain thanks to their innovative technical structure. The profile can be integrated into the floor like a tile, which means even tilers can work with Geberit CleanLine without a hitch.

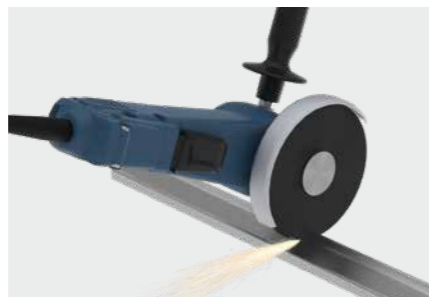

PRECISE

The Geberit shower channels in the CleanLine series can be individually cut to length directly during installation and adapted to the showering area. The various design options offer suitable solutions for every floor type. The shower channel can be positioned centrally in the shower or close to the wall.

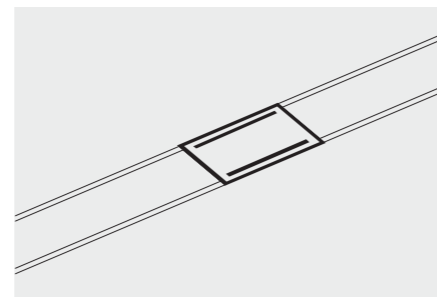

CONNECTING PIECES FOR COMMUNAL SHOWERS

Geberit offers connecting pieces designed to combine multiple shower channels for communal shower systems into a cohesive visual unit.



SOUND-DECOUPLED BASE UNIT

Certified compliance with sound insulation requirements. The trap is available for two different installation heights: minimum 6.5 cm or minimum 9 cm.



ADDITIONAL CONNECTION FOR THE WASHBASIN DRAIN

Installation set with lateral outlet for connection of a washbasin drain, rotatable by 360°

GEBERIT CLEANLINE SHOWER CHANNEL

CleanLine80

Surface: champagne / brushed, coated
Material: Stainless steel

→ **154.440.39.1**
Length: 30 - 90cm

→ **154.441.39.1**
Length: 30 - 130cm



Surface: black chrome / brushed, coated
Material: Stainless steel

→ **154.440.KS.1**
Length: 30 - 90cm

→ **154.441.KS.1**
Length: 30 - 130cm



Surface: black chrome / brushed, coated
Material: Stainless steel

→ **154.440.QC.1**
Length: 30 - 90cm

→ **154.441.QC.1**
Length: 30 - 130cm

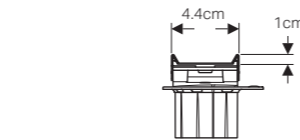

30-90cm or 30-130cm

*Order additionally Cleanline installation set

CleanLine60

For Thin Floor

Surface: Brushed metal
Material: Stainless steel

→ **154.458.00.1**
Length: 30 - 90cm

→ **154.459.00.1**
Length: 30 - 130cm

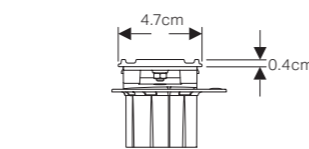

30-90cm or 30-130cm

*Order additionally Cleanline installation set

GEBERIT CLEANLINE SHOWER CHANNEL

CleanLine50

Surface: Stainless steel, brushed
Material: Stainless steel

→ **154.446.KS.1**
Length: 30 - 90cm

→ **154.447.KS.1**
Length: 30 - 130cm



Surface: black chrome, brushed coated
Material: Stainless steel

→ **154.446.QC.1**
Length: 30 - 90cm

→ **154.447.QC.1**
Length: 30 - 130cm

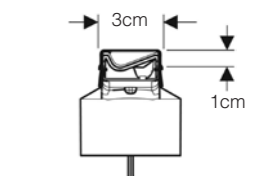

30-90cm or 30-130cm

*Order additionally Cleanline installation set

CleanLine20

Surface: brushed stainless steel
Material: Stainless steel

→ **154.450.KS.1**
Length: 30 - 90cm

→ **154.451.KS.1**
Length: 30 - 130cm

→ **154.453.KS.1**
Length: 30 - 160cm

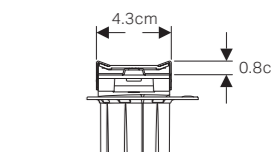

30-90cm or 30-130cm

*Order additionally Cleanline installation set

CleanLine Tile-bearing

Customised surface
Material: Stainless steel brushed

→ **154.455.00.1**

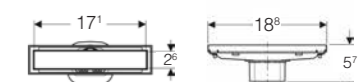
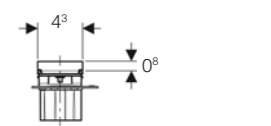
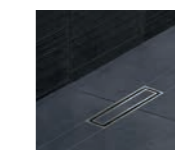

*Order additionally Cleanline installation set

GEBERIT CLEANLINE SHOWER CHANNEL

CleanLine Installation Set

With waste trap

for screed height at inlet 90–220mm

→ **154.150.00.1**

Outlet diameter: 50mm

→ **154.151.00.1**

Outlet diameter: 56mm

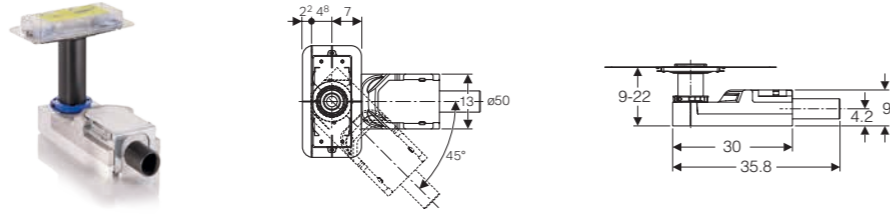

for screed height at inlet 65–90mm

→ **154.152.00.1**

Outlet diameter: 40mm

Without waste trap

for cross-floor installation

→ **154.153.00.1**

Outlet diameter: 50mm

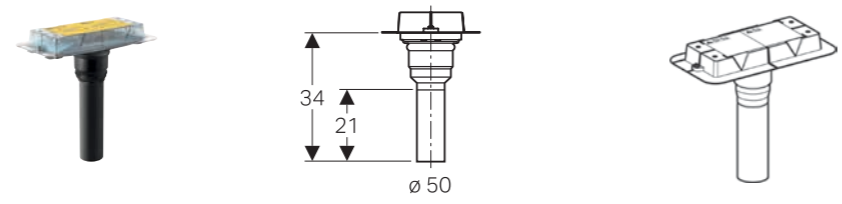

The Geberit wall drain permits floor-even showering in pure form. Integrated behind the wall, it is outstanding not only for its elegance but also for its clear added value in terms of planning, installation and maintenance.



Floor-even access for completely tiled shower areas



No interruption of the floor surface caused by the drain



Continuous tiling on the floor



DESIGN SOLUTION BEHIND THE WALL

- Innovative solution for integration in prewall systems
- Clear separation of trades thanks to pipe placement behind the wall
- Optional collector profile for efficient and precise formation of the slope in the floor



FOR NEW CONSTRUCTION AND RENOVATION

The Geberit wall drain for showers is the answer customers have been waiting for when it comes to bringing their dream designs to life. Not only is it suitable for use in a wide range of applications, but the system technology allows wall drains to be installed in all bathrooms featuring a prewall installation system – even in renovations or where space is limited.

COLOURS/PRODUCT MATERIALS

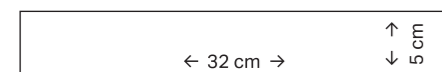

Stainless steel polished



Stainless steel brushed



Black matt



Bright chrome-plated

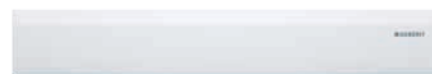

White alpine



Tiled according to preference

NEW



DEVELOPED FOR OPTIMUM HYGIENE

The Geberit wall drain for showers features an integrated comb insert that can be removed and washed out in no time at all. The cleaning of the shower floor is particularly simple thanks to the uninterrupted floor.



WELL-THOUGHT-OUT ALL DOWN THE LINE

The optionally installable collector profile directly in front of the wall supports the slope and collects dirt and deposits so that they can be readily washed away.

Duofix Wall Drain, Half Frame

→ 111.591.00.1
Discharge outlet: 50mm

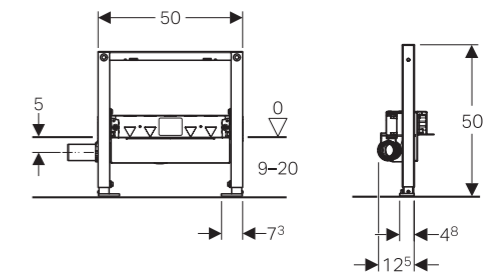

→ 111.593.00.1
Discharge outlet: 40mm

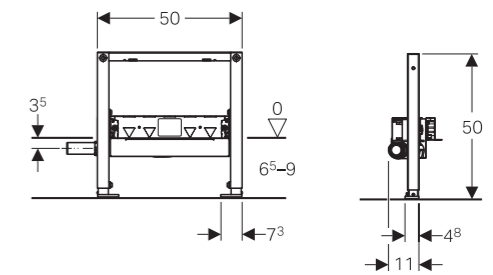

Wall Drain Cover

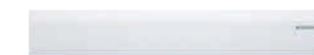
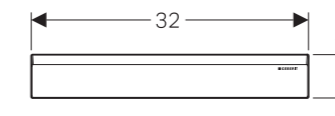

→ 154.335.11.1
White
Material: Plastic



→ 154.335.14.1
Black matt
Material: Plastic

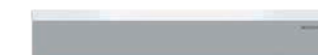

→ 154.335.21.1
Bright chrome-plated
Material: Plastic



→ 154.336.FW.1
→ 154.337.FW.1 (lockable)
Stainless steel brushed
Material: Stainless steel



→ 154.338.00.1 (frameless)
→ 154.339.00.1
Customisable surface



The Geberit floor drain is the universal solution for floor-even showers. It offers a number of clear benefits, including a minimalist design, ingenious functionality and easy installation.



Various design covers



Easy to clean thanks to integrated comb insert



Threshold-free access for floor-even shower areas

GEBERIT FLOOR DRAIN

SIMPLE AND COMPACT

- Intelligent details for an uncomplicated installation
- Design grating made of solid stainless steel
- Compact structure
- Reliable seal with sealing foil injected ex works



MAXIMUM REDUCTION AND PRECISION

The Geberit shower floor drain sets itself apart thanks to its extremely compact construction with a grating area of only 8 × 8 cm along with its exceptional functionality. The height, inclination and offset of the grating can be adjusted to suit the tile grid.

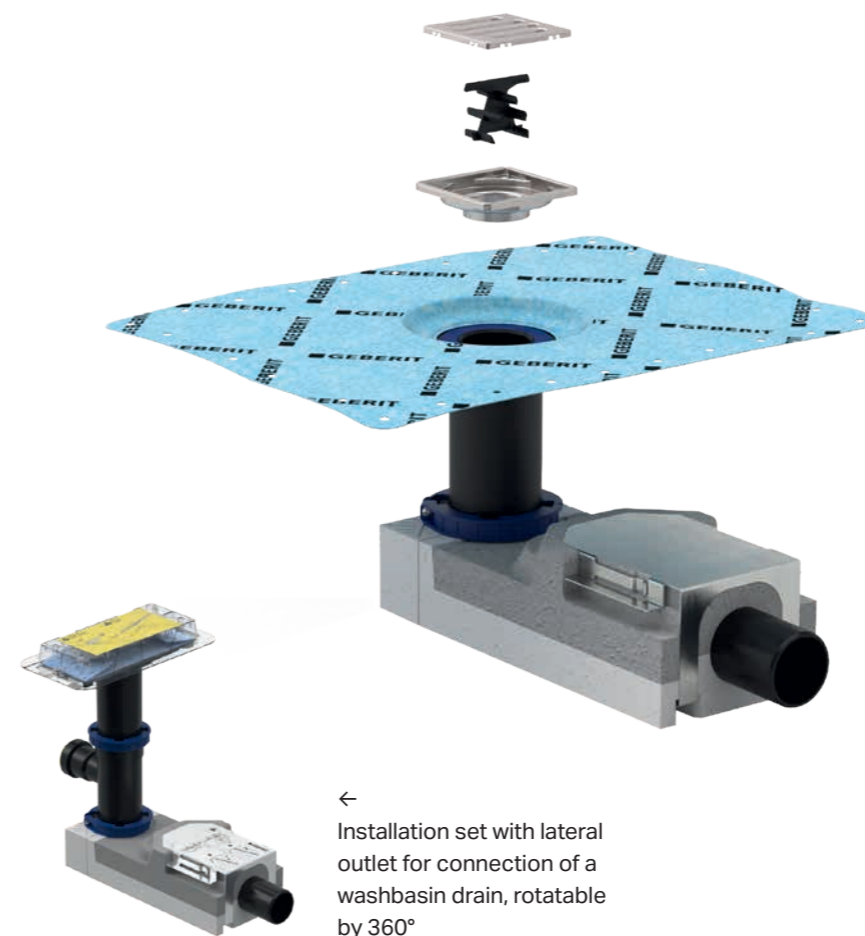

← Installation set with lateral outlet for connection of a washbasin drain, rotatable by 360°



ALWAYS A CLEAN DRAIN

Under the grating, there is an integrated comb insert that can be easily removed and washed out for cleaning. This prevents clogging in the drain and the discharge pipes.

BIG PERFORMANCE IN A SMALL PACKAGE

When installation needs to be as simple as possible and costs kept as low as they can be, the Geberit floor drain is the best solution – and a very compact one at that, with a grating area of only 8 × 8 cm. Hidden under the grating are the great qualities that make Geberit one of the world's leading providers of sanitary technology.

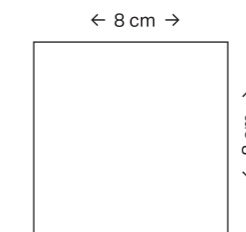

Stainless steel, round



Stainless steel, square

GEBERIT FLOOR DRAINS

Floor Drain Grating

Lockable

→ 154.310.00.1
Stainless steel brushed
Material: Stainless steel

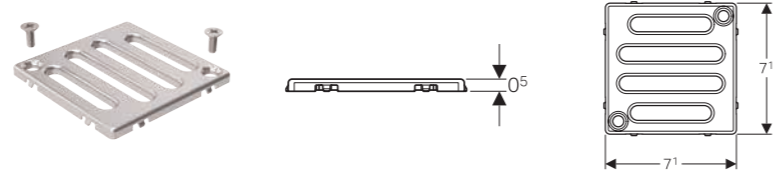

Circle

→ 154.311.00.1
Stainless steel brushed
Material: Stainless steel

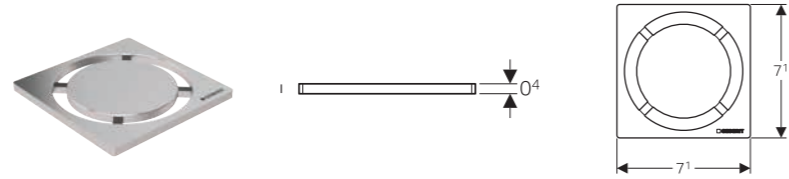

Square

→ 154.312.00.1
Stainless steel brushed
Material: Stainless steel

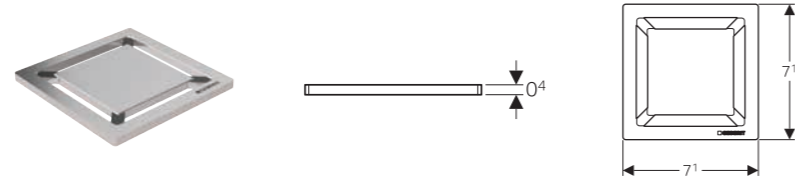

Floor Drain

→ 154.050.00.1
Floor construction height from 90mm

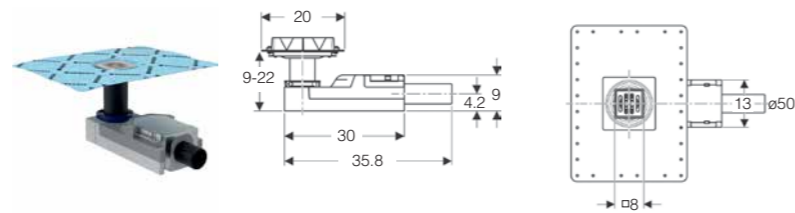

→ 154.052.00.1
Floor construction height from 65mm

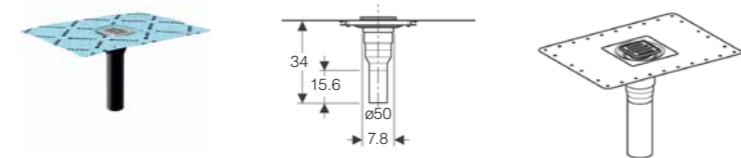

→ 154.053.00.1
Cross-floor installation

The Geberit Aquorea II is the universal solution with intergrated trap and offers a number of clear benefits, including a various design, ingenious functionality and easy installation



Various design covers



Odour free with patented silicone membrane



Threshold-free access for floor-even shower areas

GEBERIT AQUOREA II FLOOR DRAIN

ODOUR FREE FLOOR DRAIN

- Drain with membrane to prevent dehydration – water seal lasts five times longer
- For same floor drainage with horizontal outlet
- Low installation height and big flow rate (0.8 l/s)

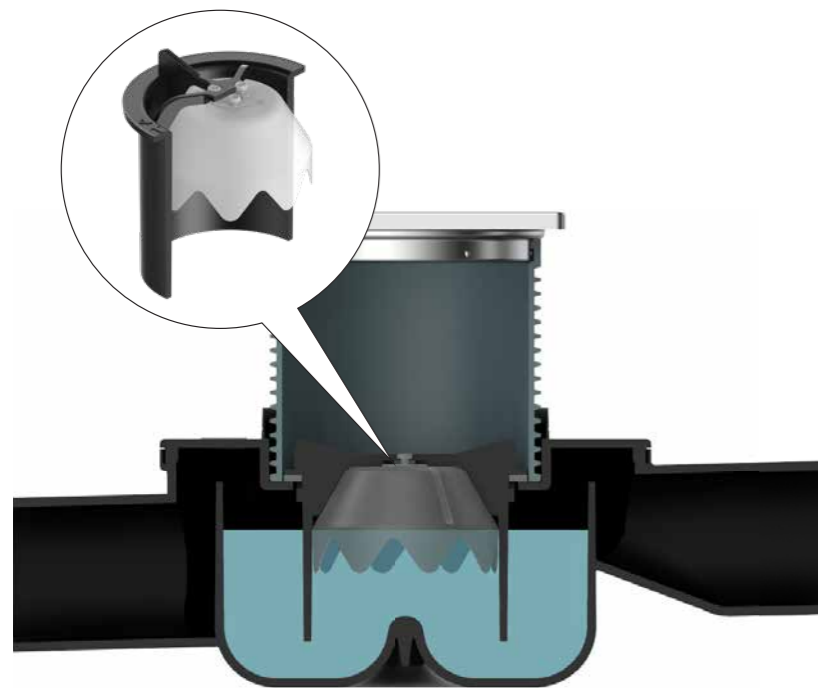

INSECT PROOF AND ODOUR PROOF

Up to 5 months of odour-free protection thanks to the special design and patented silicone membrane. The Geberit floor drain Aquorea also offers easy maintenance, installation and a big flow rate.

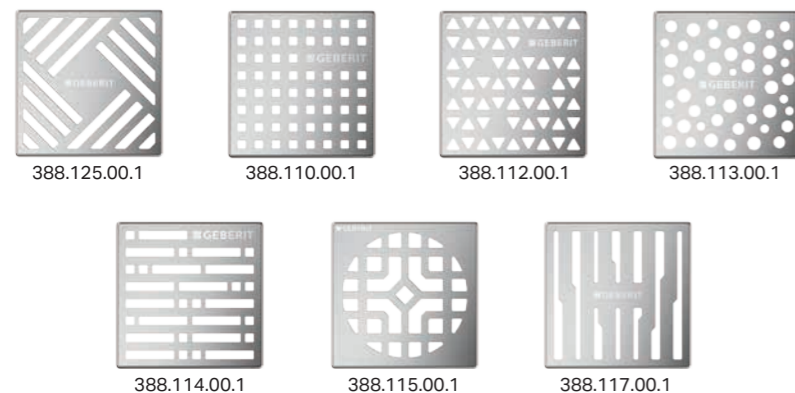

PROTECT LAYER OF WATERPROOF

The protective edge design can effectively prevent the waterproof layer from being damaged and ensure the construction quality.



CONVENIENT CONSTRUCTION

New 4 guided line to connect pipe to facilitate alignment of HDPE pipe and reduce horizontal installation difficulty.

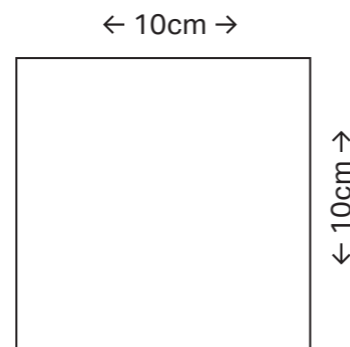

GEBERIT FLOOR DRAIN AQUOREA 2

Floor Drain Aquorea

Slotted Grating, Rear Inlet

→ 388.011.00.3
Material: PE-HD

*Order the grating separately

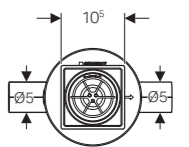
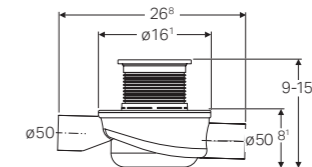

Slotted Grating

→ 388.012.00.3
Material: PE-HD

*Order the grating separately

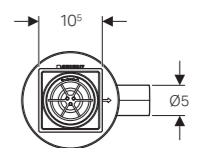
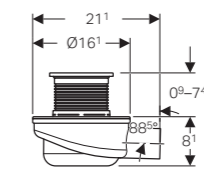

Hole Grating

→ 388.013.00.2
Material: PE-HD

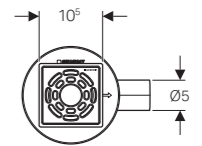
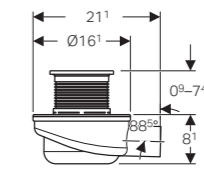

Tile-bearing, Rear Inlet

→ 388.123.00.2
Material: PE-HD

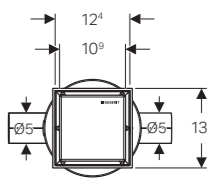
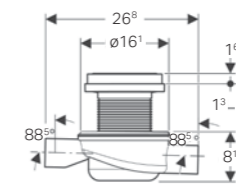

Tile-bearing

→ 388.121.00.2
Material: PE-HD

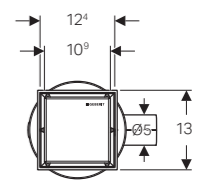
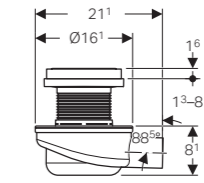

→ ODOUR-FREE WITHOUT WATER REFILL

Up to 5 months of odour-free protection thanks to the special design and patented silicone membrane. The Geberit floor drain Aquorea also offers easy maintenance, installation and a big flow rate.

GEBERIT FLOOR DRAIN AQUOREA 2

Design Gratings

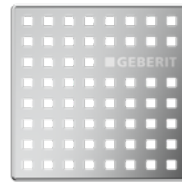

Squares design grating
388.110.00.1



Ocean design grating
388.111.00.1



Triangles design grating
388.112.00.1



Bubbles design grating
388.113.00.1



Sequential design grating
388.114.00.1



NeoChinese design grating
388.115.00.1



Piano design grating
388.117.00.1



Fractal design grating
388.125.00.1



GEBERIT FLOOR COLLECTOR DRAIN

Floor Collector Drain

→ **388.001.00.1**
Outlet: 75mm, H198mm
Material: PE-HD
For cross-floor installation

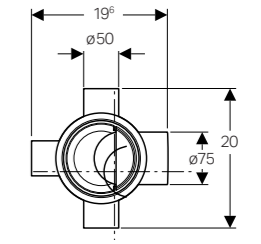
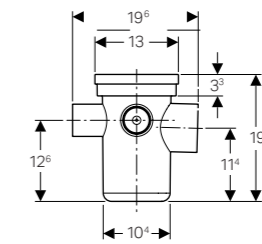

→ **388.007.00.1**
Outlet: 75mm, H150mm
Material: PE-HD
For same floor installation

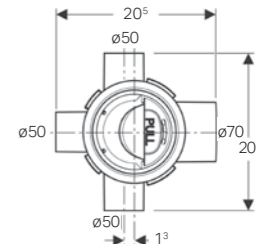
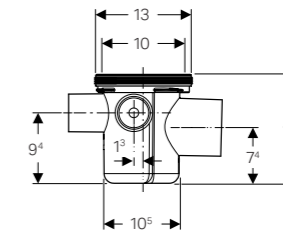

→ **388.008.00.1**
Outlet: 75mm, H150mm
Material: PE-HD

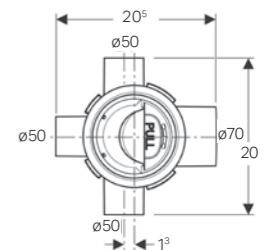
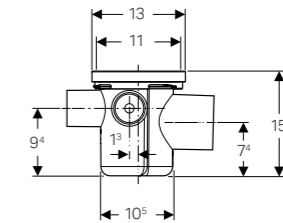

Grating for Floor Collector Drain

→ **388.009.00.1**
For same floor installation

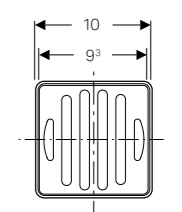
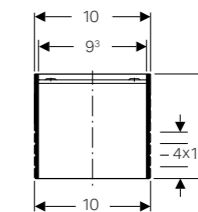

→ **388.005.00.1**
Frame and cover material -
Stainless steel
For cross-floor installation

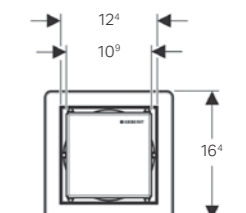
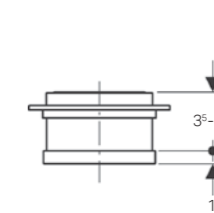
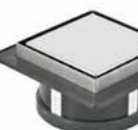

Adapter to PVC

→ **154.297.00.1**
Size: D40
Material: Plastic

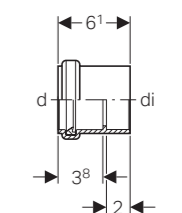

→ **154.298.00.1**
Size: D50
Material: Plastic

**Geberit South East Asia Pte Ltd
Regional Headquarters**

Aperia Tower 1
8 Kallang Avenue, #17-09
Singapore 339509

T +65 6250 4011
F +65 6250 4211
sales.sg@geberit.com

www.geberit.com.sg

South Korea Office

#301 JS Building, 213-5 Nonhyun-Dong,
Gangnam-Gu, 135-090 Seoul,
South Korea

T +82 2 543 4166
F +82 2 543 4123
sales.kr@geberit.com

www.geberit.co.kr

Hong Kong Office

Unit B, 11th Flr, CKK Commercial Centre,
289 Hennessy Road, Wan Chai
Hong Kong

T +852 2575 5960
F +852 2575 2667
sales.hk@geberit.com

Taiwan Office

4F-6, No.57, Sec 1, Dunhua S. Road,
Songsan Dist., Taipei City 10557,
Taiwan

T +886 2 2579 8736
F +886 2 2577 3365
sales.tw@geberit.com

Malaysia Office

Q Sentral, Level 35-02 (East Wing)
2A, Jalan Stesen Sentral 2, KL Sentral,
Kuala Lumpur 50470
Malaysia

T +60 3 2731 9228
F +60 3 2731 9399
sales.sg@geberit.com

Thailand Office

True Digital Park West, Unit SH572, 5th level 111
Sukhumvit Road, Bangchak, Phra Khanong,
TH-10260 Bangkok

sales.sg@geberit.com

Philippines Office

Unit 4104, Regus GT Tower, 41/F
GT Tower Building, Ayala Ave., cor dela
Costa St., Makati City, Metro Manila, 1224
Philippines

T: +63 2 8651 6546
F +63 2 840 6501
sales.sg@geberit.com

Vietnam Office

9th Floor, WorkPlace PL2,
16 Nguyen Truong To Street,
Ward 12, District 4,
Ho Chi Minh City
Vietnam

sales.sg@geberit.com

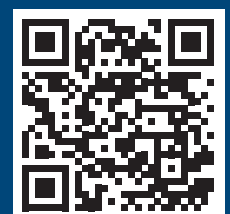

Geberit Online Catalogue